

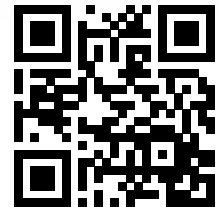





10.8

<http://tiny.cc/10seriesEN>**NEW**

 TIPPING LOAD 2700 kg	 ENGINE POWER 72 hp	 SPEED 32/40 km/h	 FLOW RATE 95 l/min	 LIFT HEIGHT 3,21 m
--	---	--	--	--

Model	10.8
Engine	Yanmar 4TNV98
Power (Iso Gross)	72 HP
Fuel	Diesel
Transmission	Hydrostatic
Drive speed (max.) - 2 speed	16-32 km/h (10-20 mph) 20-40 km/h (12.4-24.8 mph)
Aux. hydraulics oil flow	95 l/min (25 gal/min)
Max. lifting height	3,21 m (126.4 in)
Tipping load, max ⁽¹⁾	2700 kg (5952 lbs)
Lifting capacity straight ⁽²⁾	2160 kg (4762 lbs)
Lifting capacity fully articulated ⁽³⁾	1700 kg (3748 lbs)
Breakout force / 50 cm	2600 kg (5732 lbs)
Pushing force (c)	2650 kgf (2650 kp)
Specific ground pressure (w/standard tires)	874 kg/m ² (179 lbs/sqft)
Turning radius: inside/outside	1030/2550 mm (40.5/100.4 in)
Standard tires (Tractor profile)	31X15.50-15 (400/50-15)
Weight	2140 kg (4718 lbs)
Product Code	C966000
Price	

Features

- 4WD hydrostatic Direct Drive motors
- DBS (Dynamic Block System)
- Torque divider
- Engine power control
- Self-levelling double-H telescopic boom
- 11-functions joystick
- Multi-disk parking brake
- Radial Piston Wheel Motor
- 2 Speed
- Hydraulic oil cooler
- Hydraulic multiconnector
- ROPS-FOPS Level I
- LCD graphic display with programmed service (tachometer, hour meter, fuel gauge, maintenance light, light indicator and other 14 indicators)
- 2 front working light
- Ergonomic full adjustable suspension seat with armrests and safety belt.

Tires size	Width (N)	Height (Q)
31X15.50-15	1500 mm (59 in)	2150 mm (84.6 in)
29X12.50-15	1420 mm (55.9 in)	2100 mm (82.7 in)

⁽¹⁾ Maximum load that can be lifted just off the ground when the machine is straight, with backweights and boom not extended. Weight of attachment included.

⁽²⁾ Machine straight, with backweights and boom not extended. Weight of attachment is included. (80% of tipping load)

⁽³⁾ Machine fully articulated, with backweights and boom not extended. Weight of attachment is included.

MULTI ONE

10.8 FEATURES AND OPTIONS

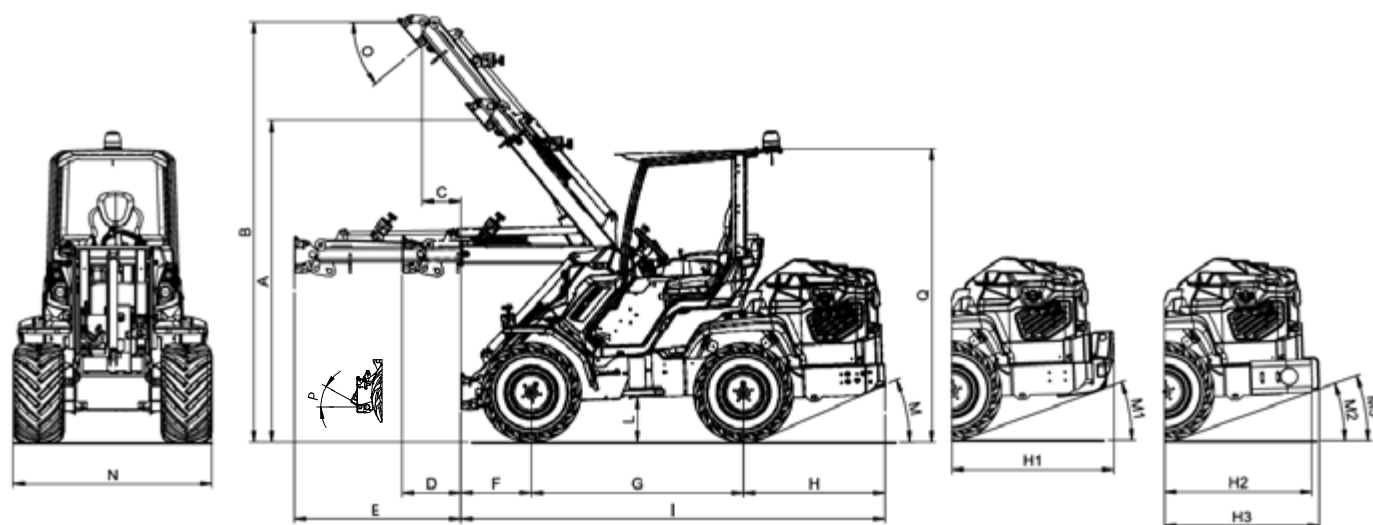

DIMENSIONS (mm / in)

A - Pivot point height (not extended boom)	2530/99.6	I - Machine length (without backweights)	3200/126
B - Pivot point height (extended boom)	3210/126.4	L - Ground clearance	340/13.4
C - Outreach with lifted boom (extended boom)	460/18	M - Angle of departure (without backweights)	24°
D - Outreach with orizontal boom (not extended)	460/18	M1 - Angle of departure (with 440 kg backweights)	19°
E - Outreach with orizontal boom (extended)	1256/49.5	M2 - Angle of departure (with 184 kg backweights - side)	19°
F - Front length	530/20.8	M3 - Angle of departure (with 184 kg backweights - rear)	19°
G - Wheelbase	1600/63	N - Max width (with standard tires)	1500/59
H - Rear length (without backweights)	1070/42	O - Dump angle	31°
H1 - Rear length (with 440 kg backweights)	1225/48.2	P - Rollback angle	29°
H2 - Rear length (with 184 kg backweights - side)	1115/43.9	Q - Height (with standard tires)	2150/84.6
H3 - Rear length (with 184 kg backweights - rear)	1170/46	Q1 - Height with A/C (with standard tires)	2350/92.5

10.8 FEATURES AND OPTIONS

Options	Code	Price
Floating boom valve	C883011	
Luxury cabin (glass)	C883001	
Heating system	C883002	
Plexiglass windscreen (smart cabin)	C883000	
Plexiglass right side (smart cabin)	C883034	
Plexiglass back window (smart cabin)	C883035	
Led Road lights "Hella"	C883010	
3 additional working led light "Hella"	C883018	
Automatic locking plate	C883008	
Attachment coupling plate for rear mounting	C880031	
Multiconnector to quick coupling 3 lines adapter	C880221	
Trailer coupling	C885017	
Additional backweights (184 kg / 406 lbs)	C880054	
Additional backweights (440 kg / 970 lbs)	C885025	
Back up alarm	C883021	
"Luxury" heated seat	C883006	
220 V engine block heater	C885250	
110 V engine block heater	C885255	
Left protection bar for operator	C883020	
Rear 12V electric socket	C883023	
Air conditioning	C883100	
Rear hydraulic outlets - single	C883015	
Rear hydraulic outlets - double	C883016	
Additional front hydraulic outlets	C883026	
Wheel spacer 10 mm (0.2 in) (max. 1 pcs for wheel)	C880090	
Wheel spacer 55 mm (2.2 in), set of 4	C885010	
Biodegradable oil	C883032	
Snow chains for wheel	see page 58	
Driver area cover	C880049	

10.8 FEATURES AND OPTIONS

Options	Code	Price
Beacon light	C883039	
Tractor tires 26x12.00-12 ET-50, set of 4	C884009	
Garden tires 26x12.00-12 ET-50, set of 4	C884010	
Skid tires 27x8.50-15, set of 4	C884011	
Skid tires 27x10.50-15, set of 4	C884012	
Garden tires 400/50-15, set of 4	C884013	
Rear bumper	C883037	